

# Book – Titti Fabiani design



Il Book e la sua filosofia.

Titti Fabiani parte dai concetti geometrici enunciati dal Gruppo Bauhaus negli anni 30 e li sviluppa creando un rapporto vivo e dinamico fra forma e funzione.

Il quadrato che caratterizza tutta la serie è la sintesi di questa creazione con le sue proporzioni, i rapporti fra i pieni delle cornici e i vuoti delle specchiature.

Ed è proprio il quadrato che incorniciando il contenuto del mobile, mettendolo in valore, diventa nella sua assoluta elementarietà, del tutto originale.

Le sue dimensioni, studiate accuratamente in relazione sia al valore decorativo sia alla funzione, e la relazione fra gli elementi che compongono il mobile, rendono il Book un'opera immediatamente riconoscibile, identificabile.

Originale e attuale nell'uso innovativo di una forma elementare.

La composizione dei quadrati a due, a tre, a quattro e a sei per volta, obbedisce ad una precisa scelta che equilibra in maniera rigorosa la funzione e l'estetica.

Book è stata accolta fin dal 1969 dalla stampa specializzata e dai mezzi di informazione di massa, come una assoluta innovazione e come uno di quei "pezzi" dal valore assoluto destinati a rimanere unici e inimitabili. Pezzi come la sedia Cesca o la poltrona Wassily di Breuer, la lampada Arco di Castiglioni, la Chaise Longue di Le Corbusier, le sedie di Mc Intosh. Che non si inseriscono quindi in alcuno stile preciso, ma attraverso la loro unicità hanno un contenuto universalmente valido che consente loro di essere giusti in qualsiasi ambiente o epoca, dove sono protagonisti e nel contempo valorizzatori degli altri oggetti.

Certo Titti Fabiani non ha inventato il quadrato, ma l'ha usato in modo originale.

The Book Philosophy

Titti Fabiani starts from the geometrical concepts of the 1930s Bauhaus movement and develops them through a living and dynamic relationship between form and function.

The square that characterizes the whole series is a synthesis of this approach – through its proportions, the relationship between volume of the frames and empty surfaces.

Thus the square which frames the furniture content – making it important – becomes, through its simplicity, totally original.

Its dimensions – carefully studied keeping in mind both decoration and functionality – and the relationship between its elements make Book an immediately recognizable work of art. Original and contemporary by its innovative use of an elementary geometry. The square composition – two, three, four, six – follows a precise choice that rigorously balances function and aesthetic.

Book has been welcomed since 1972 by specialized and mass media as an absolute innovation and as one of those design achievements which will last forever, unique and without any possible imitation. Pieces like the Cesca chair or the Wassily armchair by Breuer, Arco lamp by Castiglioni, Chaise Longue by Le Corbusier, the McIntosh chairs. These are not part of any precise style, but whose uniqueness give them a universal value – making them at ease in every space and time, where they are protagonists and at the same time highlight the other objects value.

Titti Fabiani did not create the square – but created a unique way of using it.

TITTI FABIANI

THE BOOK OF BOOK

NOW IN COLOUR

WWW.IDEALFORMTEAM.COM





A new Titti Fabiani's design  
to wipe out the dullness around us  
and fill the home with vital force.

Cheerful and aggressive, or  
poetic and dreamy,  
hung on a wall  
in a bright many-coloured line,  
Book Colour is a new,  
unpredictable look.

Because life is  
a constant movement.

Un nouveau projet par Titti Fabiani  
pour effacer la monotonie autour de nous  
et remplir l'espace avec de la force vitale.

Joyeux et agressif, ou  
poétique et rêveur,  
accroché au mur  
comme une lumineuse ligne multicolore  
Book Colour est un style nouveau,  
imprévisible.

Parce que la vie est  
un mouvement continu.

Ein neues Projekt von TittiFabiani, mit  
dem Sie das Grau aus Ihrem Alltag ver-  
bannen und den Raum mit Lebensfreude  
füllen.

Fröhlich und frech, oder poetisch und  
verträumt – das Hängeregal Book Colour  
in der hellen Multicolor-Reihe gibt Ihrer  
Wohnung einen überraschend neuen  
Look.

Weil Leben bedeutet,  
dass alles in Bewegung ist.

Un nuovo progetto  
di Titti Fabiani  
per cancellare il grigio  
che ci circonda  
e riempire lo spazio  
di forza vitale.

Allegro e sfrontato,  
o poetico e sognante,  
appeso alla parete  
in una luminosa linea  
multicolore,  
Book Colour  
è un look nuovo,  
imprevedibile.

Perché la vita è  
continuo movimento.







Let the sunshine in. When it rains too.

Le soleil chez nous. Même s'il pleut.

Lass die Sonne rein. Auch wenn es regnet.

Il sole in casa. Anche quando piove.





Architecture means strict rules. It's nice breaking them.  
L'architecture a des règles sévères. Il est beau de les casser.  
Architektur folgt strengen Regeln. Es macht Spaß, sie zu brechen.

L'architettura ha regole severe. Il bello è romperle.







Niente è meglio  
del proprio cinema  
personale.

Nothing better than my private movie theatre.

Rien n'est mieux que mon cinéma privé.

Es gibt nichts schöneres als das eigene Heimkino.











Living surrounded by art pieces.

Vivre parmi des oeuvres d'art.

Wohnen umgeben von Kunstwerken.

Vivere tra opere d'arte.







E poi Baloo afferrò Shere Khan per la coda e la fece volare.  
Le scimmie ridevano.



Then Baloo seized Shere Khan by its tail  
and made it fly. The monkeys laughed.

A ce moment là Baloo saisit Shere Khan  
par la queue et le fit voler.  
Les singes riaient.

Und dann packte Baloo Shere Khan beim  
Schwanz und wirbelte ihn durch die Luft.  
Die Affen lachten.









Let's weigh anchor. Calm seas and favorable winds wait for us.

Levons l'ancre. Des mers calmes et des vents favorables nous attendent.

Leinen los. Die See ist ruhig und der Wind günstig.

Salpiamo. Ci aspettano mari calmi e brezze favorevoli.











È di moda l'Oriente.

Far East is fashionable. But how much loving is the Italian cuisine...

L'Orient est à la mode. Mais la cuisine italienne est tellement affectueuse...

Fernost ist in Mode. Aber es geht nichts über die italienische Küche...

Ma come è affettuosa la cucina italiana...









Summer here again.  
Music plays sweetly, drifting.  
And life is renewed.

L'été revient.  
Le koto joue une musique douce.  
Et la vie se renouvelle.

Der Sommer ist zurück.  
Der Koto ertönt leise.  
Und das Leben erneuert sich.

Torna l'estate.  
Il koto suona dolcemente.  
E la vita si rinnova.



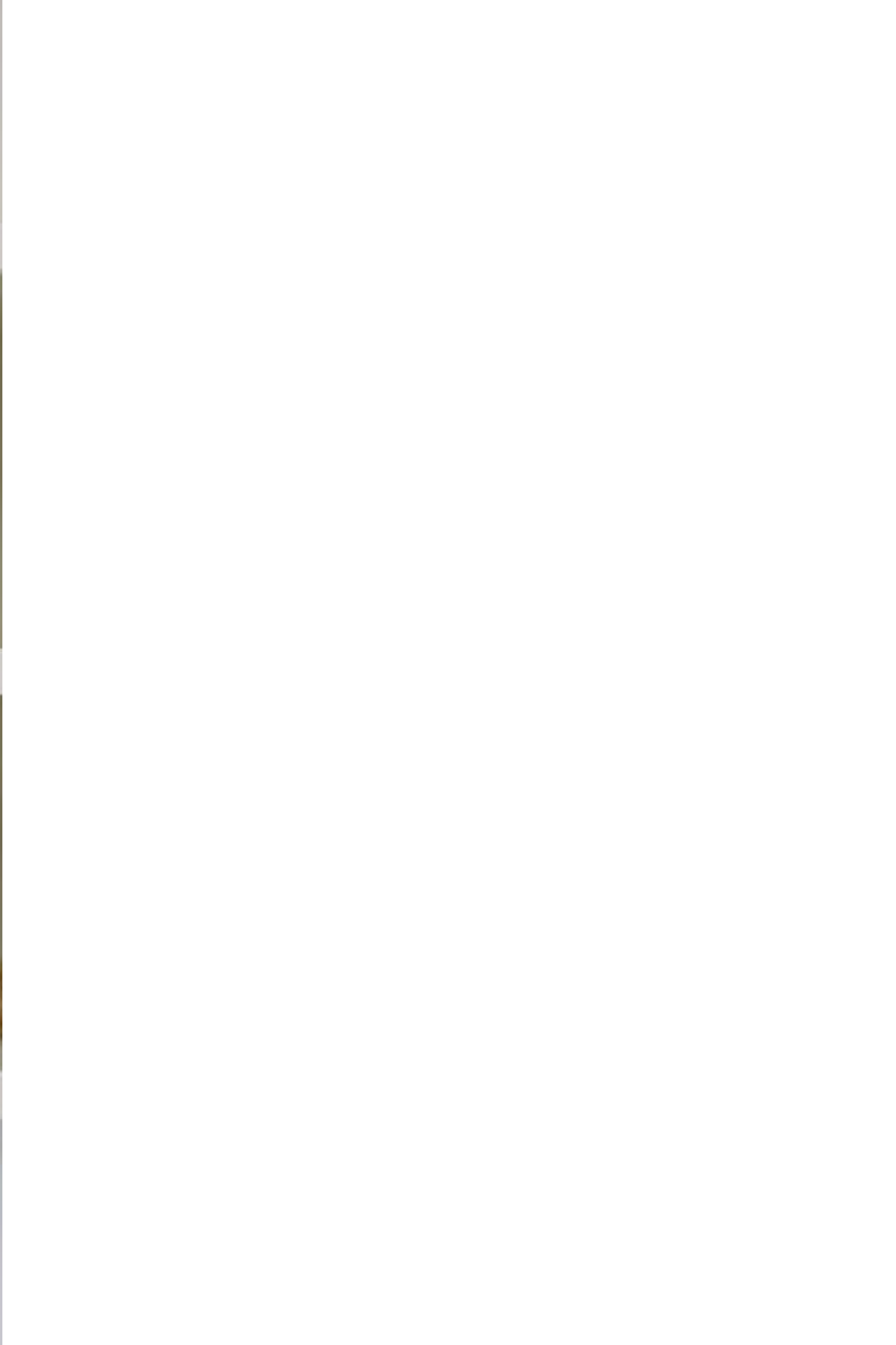





Tender is the night among your arms.

Tendre est la nuit parmi tes bras.

Sanft ist die Nacht in deinen Armen.

Tenera è la notte tra le tue braccia.











Piero della Francesca as seen from Venice.

Piero della Francesca vu par Venice.

Piero della Francesca von Venedig aus betrachtet.

Piero della Francesca visto da Venezia.







But Book is not only these new colours  
and this new and free way to compose a wall.  
Book is a design born many years ago.  
It was created in 1969 by Titti Fabiani  
who needed it to keep her many books at home.  
Since then it has become the architects'  
and designers' favourite bookcase  
all over the world.  
Maybe because it's cool and simple.  
It is minimal and elegant,  
open to many different uses  
and incredibly well made:  
ask somebody who has it since more than 40 years.  
Do you like to learn its story?  
it is funny and special.

Mais le Book n'est pas seulement ces couleurs  
et cette façon nouvelle et libre de composer.  
Book est un projet né il y a beaucoup de temps.  
Dessiné en 1969 par Titti Fabiani  
pour le remplir des nombreux livres chez soi,  
il est devenu la bibliothèque préférée  
d'architectes et designers dans le monde entier.  
Peut-être parce qu'il est poli et jamais envahissant.  
Minimaliste mais élégant,  
prêt à différentes utilisations  
et incroyablement bien construit:  
demandez à ceux qui l'ont depuis plus de 40 ans.  
Voulez vous connaître son histoire?  
Elle est amusante et particulière.

Aber Book ist mehr als neue Farben und diese  
ungewöhnliche, freie Art, eine Wand zu gestalten.  
Book ist vor vielen Jahren entstanden.  
Nach einem Entwurf von Titti Fabiani,  
die Platz für ihre unzähligen Bücher brauchte.  
Und daraus ist das beliebteste Bücherregal  
der Architekten und Designer  
in der ganzen Welt geworden.  
Vielleicht weil es so glatt und zurückhaltend ist.  
Minimalistisch und elegant, vielseitig einsetzbar  
und unglaublich gut gemacht:  
Fragen Sie jemanden, der es seit mehr als 40 Jahren  
besitzt.  
Wollen Sie seine Geschichte hören?  
Sie ist lustig und außergewöhnlich.

Ma il Book non è solo  
questi nuovi colori  
e questo modo nuovo e libero  
di comporre una parete.  
Book è un progetto  
nato molti anni fa.

Disegnato nel 1969 da Titti Fabiani  
per i tantissimi libri in casa.  
E da lì è diventato la libreria preferita  
da architetti e designer in tutto il mondo.  
Forse perché è levigato e non invadente.  
Minimalista ma elegante.  
Duttile nell'utilizzo.  
E tremendamente ben costruito:  
chiedete a chi ce l'ha da più di quarant'anni.

**Volete conoscere la sua storia?  
È curiosa e particolare.**





**N**on capita a tutti di  
disegnare un prodotto  
e vederlo scegliere  
subito da un Mostro  
Sacro del Design.

È capitato a Titti Fabiani con il Book.

Erano gli anni '70. Salone del mobile.  
Achille Castiglioni si ferma davanti al  
Book. Lo guarda, lo apre, si allontana,  
lo riguarda, passa le dita sugli incavi  
per l'apertura, si complimenta e dice...  
che lo vuole per casa sua!

Having a design titan choose the cabinet  
you've created – upon first sight, no less –  
doesn't happen to everybody. But it happened  
to Titti Fabiani when she designed Book.  
It was in the 1970s – at the Milan Salone del  
Mobile – Achille Castiglioni stopped and looked  
at Book. He looked again, opened it, walked  
away, came back, looked at it again, ran his  
fingers over the grooves made for opening the  
cabinet, congratulated her and ordered it  
for his home.

Il n'est pas donné à tout le monde de dessiner un  
produit qu'un Monstre Sacré du Design choisit  
immédiatement. C'est arrivé à Titti Fabiani avec  
son Book. C'était dans les années 70. Au Salon  
du Meuble de Milan.

Achille Castiglioni s'arrête devant le Book.  
Il le regarde, l'ouvre, s'éloigne, le regarde  
encore, passe ses doigts sur les rainures de  
l'ouverture, félicite la créatrice et dit... qu'il le  
veut pour chez lui!

Das ein Designtitan dein gerade kreierte  
Möbel auf den ersten Blick auswählt, das  
geschieht wirklich nicht alle Tage.  
Titti Fabiani ist das mit Book passiert.  
Es waren die 70er – im Salone del Mobile in  
Mailand. Achille Castiglioni bleibt vor Book  
stehen und betrachtet es. Er schaut weiter, öffnet  
es, geht weiter, kommt zurück, schaut noch mal,  
streift mit seinen Fingern über die Nuten, die  
als Öffnungsgriffe dienen, gratuliert ihr und ...  
bestellt es für sein Zuhause!





# È

È il '78 quando il Book sbarca a New York, nel grande negozio di "Abitare", aperto sulla 57esima dalla Techinteriors. Grande affluenza di designer e di pubblico.

Entusiasmo ed emozione nel sentire i Newyorchesi che balbettano in italiano, nel vedere il New York Times che, nella sezione Design, mette in prima pagina una grande foto del Book... Woody Allen sta preparando il suo "Manhattan". Ed ecco che, per la casa della protagonista, vuole l'arredo più intellettuale e manhattaniano che si possa avere: una grande parete di Book bianchi.

Book landed in New York City in 1978, in the large "Abitare" shop on 57th Street, opened by Techinteriors. The store was teeming with designers and design enthusiasts. It was very emotional to hear New Yorkers trying to speak Italian, looking at The New York Times Design Section, where Book dominated the front page. Woody Allen was preparing to shoot Manhattan. And for the main character's apartment he asked for the most intellectual and quintessentially "Manhattan" furniture available: a large white Book wall.

C'est en 1978 que Book débarqua à New York, dans le grand magasin "Abitare" que Techinteriors ouvrit dans la 57ème Rue. Les designers et le public le prirent d'assaut. C'était émouvant d'entendre les Newyorkais essayer de parler italien et de voir qu'une grande photo du Book faisait la une du New York Times, section Design... Woody Allen préparait son «Manhattan». Et pour l'appartement de son personnage féminin principal, il a voulu la déco la plus intellectuelle et la plus «Manhattan» possible : un grand mur de Book blancs.

1978 landet Book in New York, im großen Geschäft "Abitare", das Techinteriors auf der 57. Straße eröffnet hat. Es wimmelt von Designern und Designliebhabern. Es war sehr emotional zu hören, wie die New Yorker versuchten, italienisch zu sprechen,

während sie den dem Design gewidmeten Teil der New York Times anschauten, in dem Book die Titelseite beanspruchte... Woody Allen schickt sich an, "Manhattan" zu drehen. Und für die Wohnung der Hauptdarstellerin will er die intellektuellste Einrichtung haben, die es gibt, die Quintessenz Manhattans: eine große, weiße Book-Wand.









**D**opo Woody Allen, nei film è diventato di moda ambientare le scene in location con il Book. Anche lo scenografo Guido

Josia, nel film “Io Chiara e lo scuro” di Francesco Nuti, fa suonare il sax a Giuliana De Sio davanti a una parete di Book.

Since Woody Allen, it has become fashionable to use Book as a part of movie set designs.

The set design by Guido Josia, in “Io Chiara e lo Scuro” by Francesco Nuti, has Giuliana De Sio playing the saxophone in front of a Book wall.

Après Woody Allen, il est devenu très à la mode dans les films de créer des scènes avec le Book. Dans son film « Io Chiara e lo scuro », Francesco Nuti fait jouer du saxo à Giuliana De Sio devant un mur de Book.

Nach Woody Allen wurde es in Filmen modern, Book als Szeneneinrichtung zu verwenden. Auch der Bühnenbildner Guido Josia, lässt Giuliana De Sio in Francesco Nuti’s “Io Chiara e lo scuro” ein Saxophon vor einer Book-Wand spielen.





**P**iera Peroni, la geniale mente che ha fondato Abitare, quasi quarant'anni fa presenta per prima il Book in un lungo servizio sulla sua rivista, e lo titola così: "Book, una libreria per oggi, per domani, per sempre."

Almost forty years ago Piera Peroni, the brilliant founder of Abitare, first presented the Book in an extended feature article with the title "Book, a bookcase for today, tomorrow and forever".

C'est Piera Peroni, l'esprit génial qui a fondé Abitare, qui il y a près de quarante ans a présenté la première le Book dans un long article dont le titre était: «Book, une bibliothèque pour aujourd'hui, pour demain, pour toujours.»

Piera Peroni, die geniale Gründerin von Abitare, stellte Book vor fast vierzig Jahren zum ersten Mal in einem ausführlichen Artikel dar, dessen Überschrift lautete: „Book – ein Regalsystem für heute, morgen und immer.“



*...a che va bene  
per oggi per domani per sempre*









Museum Jan van der Togt  
Dorpsstraat 50, 1182 JE Amstelveen  
Telefoon 020 641 57 54  
Fax 020 645 23 35

info@jvdtogt.nl  
www.jvdtogt.nl  
RABO 38 23 96 596  
Iban NL 68Rabo0382396596

MUSEUM  
JAN VAN DER TOGT  
AMSTELVEEN

Het Museum Jan van der Togt  
is een museum voor moderne kunst  
en wordt beheerd door  
de Stichting Jan van der Togt  
Kvk 41120560  
BTW 000.706.230.001

Amstelveen, 18.01.2013  
Ref.nr. : JV/mb – B-116

**The Jan Van der Togt Museum adds a new work of art: *Book* by Titti Fabiani.**

*Book*, the celebrated creation by Milanese artist and designer Titti Fabiani, is now part of the Jan Van der Togt Museum permanent collection.

It is exhibited in the large first floor hall, where a skylight sets off the *Book* parallel crystals clearness – multiplying their voluptuous brilliance.

The refined symmetry of its shape, the minimalist linearity, the shining exclusive design were matter of choice by the Museum's curators to exhibit this work as an inventive exemple of masterly, artistic use of glassy material.

*Book* was created in 1969 and it is since a designers' and achitects' favourite – all over the world.

Linear and smooth – with a perfect ratio between wood and glass – *Book* is one of those classic creations which never stop enchanting and captivating.

The exhibit has been made possible by the contribution of IFT, Ideal Form Team, Monsano, Italy.

















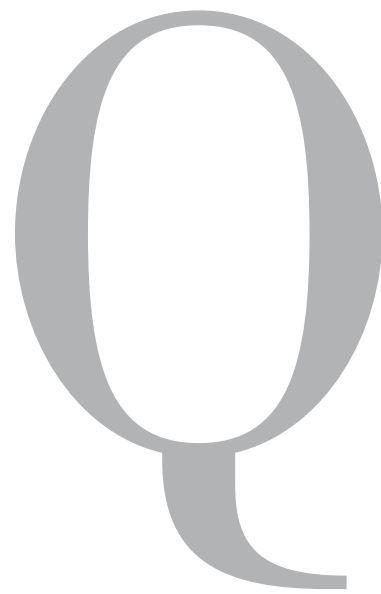

Qualche tempo fa, quasi per gioco, mi sono iscritta a Facebook (dovevo rispondere ad una intervista sui socialnetwork) e subito persone del tutto sconosciute mi hanno chiesto se ero il designer del Book, descrivendolo come un progetto straordinario, che amavano

moltissimo. O altri chiedendomi “sei la ‘grande’ Titti Fabiani designer? Quella che abbiamo spesso evocato questa estate, organizzando una mostra su Harry Bertoia?”

Some time ago, just for fun, I joined Facebook (I had to answer some questions in an interview about social networks) and immediately a number of unknown persons started asking me whether I was the Book designer – talking about it as a very special and beloved project. Others asked me “are you the ‘great’ Titti Fabiani designer? The one we often talked about last summer while organizing the Harry Bertoia exhibition?”

Il y a quelques temps de cela, presque par jeu, je me suis inscrite à Facebook (je devais répondre à une interview sur les socialnetworks) et presque immédiatement des gens que je ne connaissais pas du tout m’ont demandé si la conceptrice de Book c’était moi ; ils le décrivaient comme un objet extraordinaire qu’ils aimaient beaucoup. D’autres m’ont demandé : «c’est toi, la ‘grande’ designer Titti Fabiani? Celle qu’on a souvent évoquée cet été quand on a organisé une exposition sur Harry Bertoia?»

Vor einigen Zeit habe ich mich, eigentlich aus Spaß, bei Facebook angemeldet, denn ich musste ein Interview in Bezug auf soziale Netzwerke beantworten. Sofort haben mich mir unbekannte Personen angesprochen, die nachfragten, ob ich es sei, die Book entworfen habe und wie außergewöhnlich sie dieses Projekt finden, das sie wirklich sehr lieben. Andere fragten wiederum: „Sind sie die berühmte Designerin Titti Fabiani? Die, die wir diesen Sommer bei der Organisation einer Ausstellung über Harry Bertoia so oft erwähnten?“

















**L'**altro giorno sfogliando una rivista di arredamento mi sono fermata a guardare la casa di una giornalista che ha deciso di vivere in montagna. E leggo: "Dalla nostra residenza cittadina abbiamo portato alcuni elementi d'arredo a cui eravamo particolarmente affezionati, come la libreria Book, di Titti Fabiani, che mi accompagna di casa in casa da più di trent'anni, ma non li dimostra..." Ecco, effettivamente quando ho disegnato il Book volevo che fosse per sempre...

Sometime ago, while leafing through an interior design magazine, I saw the house of a journalist who had decided to live in a small town in the mountains. In the article I read: "From our city home we took a few elements we are especially fond of, like the Book bookcase, by Titti Fabiani, which has come with me for the past thirty years from one home to another – though it does not look it..." That's what I wanted when I designed the Book – for it to last forever.

L'autre jour, alors que je feuilletais un revue de déco, j'ai regardé avec attention la maison d'une journaliste qui a décidé de s'installer à la montagne. Et je lis: «Nous avons apporté certains éléments de déco de notre maison en ville auxquels nous étions particulièrement attachés comme la bibliothèque Book de Titti Fabiani qui, depuis plus de trente ans, ne m'a jamais quitté, mais elle ne les fait pas...» Voilà, en effet quand j'ai dessiné le Book, je voulais que ce soit pour toujours...

Vor einigen Tagen habe ich in einer Einrichtungszeitschrift das Bild des Hauses eines Journalisten gesehen, der sich dazu entschieden hat, in den Bergen zu leben. Wobei zu lesen war: „Aus unserer Stadtwohnung haben wir einige Einrichtungsgegenstände mitgebracht, die wir besonders mögen. Beispielsweise das Regalsystem Book von Titti Fabiani, das uns seit mehr als dreiBig Jahren von Haus zu Haus begleitet. Sein Alter sieht man ihm aber wirklich nicht an...“ Genau. Als ich Book entworfen habe, wollte ich etwas Zeitloses schaffen...















**E**ravamo nello studio di Bruno Munari, in via Vittoria Colonna, tra centinaia di lavori, di oggetti curiosi, di esempi di design raccolti in giro per il mondo.

Mi guardava con quei suoi occhi colore del cielo, un po' strizzati in un sorriso di approvazione. Poi, dandomi uno dei suoi libricini, quello sul Quadrato, mi spiegava che il mio Book era molto bello perché basato sulla inattaccabile armonia di questa figura geometrica.

Per me l'approvazione di Bruno, uno dei più grandi maestri italiani, è sempre stata fondamentale per continuare nella mia ricerca progettuale.

We were in Bruno Munari's studio, in Milan, among hundreds of works, strange objects, and design examples gathered from around the world. He looked at me with those sky-blue eyes, squinting somewhat in an approving smile. Then, giving me one of his books – The Square – he explained to me that my Book was so beautiful because it was based on the perfect harmony of this geometrical element. Bruno was one of the greatest Italian design masters, and his approval has always been fundamental in encouraging me to continue my design research.

Nous étions dans l'atelier milanais de Munari, dans la rue Vittoria Colonna, au milieu de centaines de travaux, d'objets curieux, d'exemples de design pris ça et là dans le monde. Il me regardait de ses yeux bleu ciel qu'il clignait dans un sourire d'approbation. Puis il me donna un de ses petits livres, celui sur le Carré et m'expliqua que mon Book était très beau car il se basait sur l'harmonie parfaite de cette figure géométrique. Pour moi, l'approbation de Bruno, un des plus grands maîtres italiens, a toujours été capitale pour continuer ma recherche conceptuelle.

Wir waren im Studio von Bruno Munari, in der Via Vittoria Colonna, inmitten Hunderter Arbeiten, merkwürdiger Gegenstände, auf der ganzen Welt gesammelter Designbeispiele. Er sah mich mit seinen himmelblauen, durch sein zustimmendes Lächeln leicht zusammen gekniffenen Augen an. Dann gab er mir eines seiner Bücher, das Quadrat, und erklärte mir, dass mein Book deshalb so schön war, weil es sich auf die perfekte Harmonie dieser geometrischen Figur aufbaute. Bruno war einer der größten italienischen Designer und seine Anerkennung war für mich immer ein grundsätzlicher Antrieb, meine Suche im Bereich des Designs fortzusetzen.



















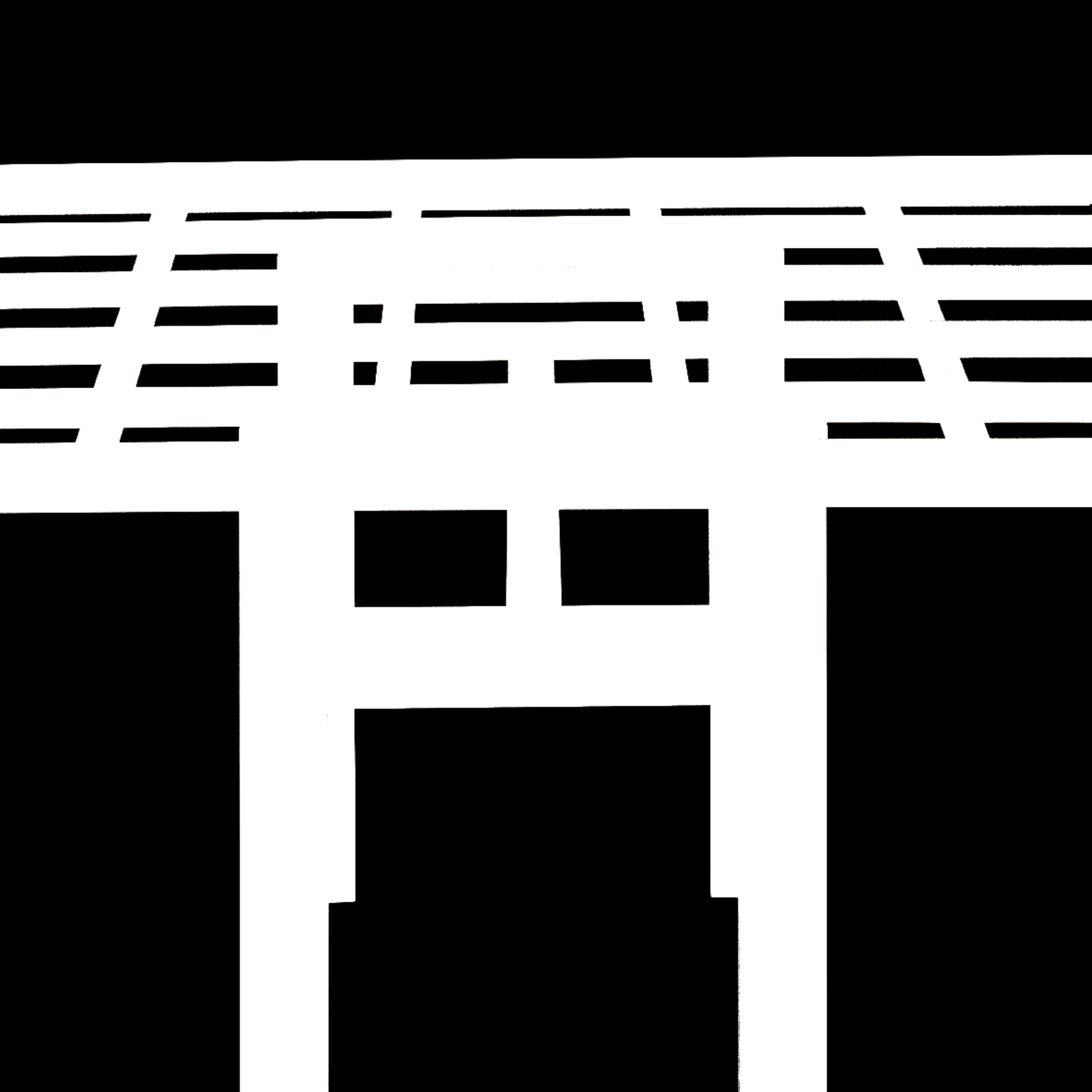



**D**opo l'ovvio tavolo Book e il mio amatissimo Basic, di cui ho riempito la mia agenzia, ho provato a disegnare un tavolo da otto che stesse a parete ed è nato Bitavolo.



After the obvious Book table and my beloved Basic, which I filled my agency with, I tried to design an eight-piece foldable table that was easy to put along a wall. This was how Bitavolo was born.

Après l'évidente table Book et mon bien-aimé Basic, dont j'ai rempli mon agence, j'ai essayé de dessiner une table pliante de huit pièces pouvant être placée le long du mur: Bitavolo était né.

Nach dem obligaten Tisch Book und meinem geliebten Basic, der in meinem Studio überall anzufinden ist, habe ich einen Tisch für 8 Personen entwickelt, der an die Wand gestellt werden kann: Bitavolo.



# U

n incontro tra design e arte.

Qualche anno fa Allegra Betti van der Noot fece un intervento su una parete di Book bianchi, coprendola di mani dai colori vivissimi. Poi la titolò

spiritosamente “Le mani sul design”.

La mistura tra il rigore del Book e la forza vitale della pittura risultò elettrizzante.

Ancora adesso se ne parla.

A meeting between Art and Design.

Some years ago Allegra Betti van der Noot covered a wall of white Book with brightly colored hands. Then she gave it the humorous title “Hands on Design”. The mix between Book’s rigor and the vitality and strength of painting was electrifying. People continue to talk about this subject.

Quand le design et l’art se rencontrent.

Il y a quelques années, Allegra Betti van der Noot fit un travail sur un mur de Book blancs: elle le recouvrit de mains aux couleurs vives.

Puis elle l’appela, non sans un trait d’esprit, «Les mains sur le design».

Le mélange entre la rigueur du Book et la force vitale de la peinture fut électrisant.

Il est encore sur toutes les langues aujourd’hui.

Ein Treffen zwischen Kunst und Design. Vor einigen Jahren bedeckte Allegra Betti van der Noot eine weiße Book-Wand mit kunterbunten Handabdrücken.

Dann gab sie der Arbeit den witzigen Titel “Die Hand am Design”.

Der Mix zwischen der Strenge von Book und der lebendigen Kraft der Malerei war elektrisierend. Noch heute wird davon gesprochen.





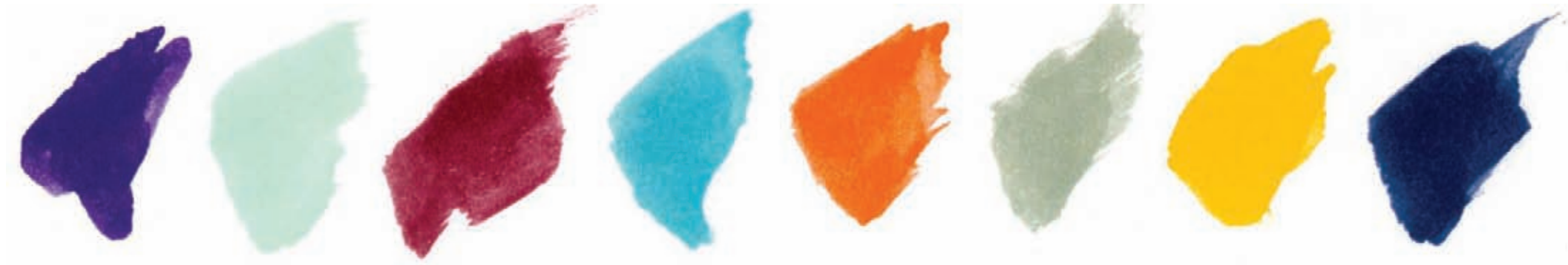

pag 62 - 63 Book Mahogany



pag 64 - 65 Book Black Gloss



pag 66 - 67 Book Walnut,  
Tavolo Laser



pag 68 - 69 Book Walnut



pag 6 - 7 Book Gold,  
Sunset, Sunny, Grapes



pag 8 - 9 Book Lipari White,  
Sunset, Ithaky, Smoky



pag 12 - 13 Book Sunny,  
Gold, Lipari White

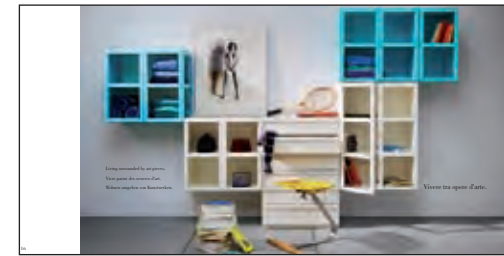

pag 16 - 17 Book Ithaky,  
Lipari White



pag 70 - 71 Book Stromboli Black



pag 72 - 73 Tel Whitened Natural



pag 74 - 75 Book Blonde Walnut



pag 76 - 77 Book Blonde Walnut



pag 20 - 21 Book Gold, Ithaky,  
Sunset, Lipari White, Sunny



pag 24 - 25 Book Navy,  
Mare, Lipari White



pag 28 - 29 Book Sunset,  
Whitened Natural, Venice



pag 32 - 33 Book Lipari White,  
Whitened Natural, Mare



pag 78 - 79 Book Mahogany



pag 80 - 81 Book Natural



pag 82 - 83 Book Mare



pag 84 - 85 Book Moka Walnut

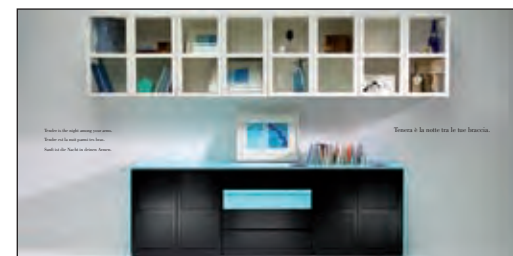

pag 36 - 37 Book Black,  
Ithaky, Lipari White



pag 40 - 41 Book Baby, Lipari White,  
Ithaky, Venice, Natural Forever



pag 48 - 49 Book Lipari White



pag 50 - 51 Book Lipari White



pag 86 - 87 Book Walnut



pag 88 - 89 Book Moka Walnut



pag 90 - 91  
Tavolo Book Stromboli Black



pag 92 - 93 Tavolo Basic,  
Bitavolo Stromboli Black

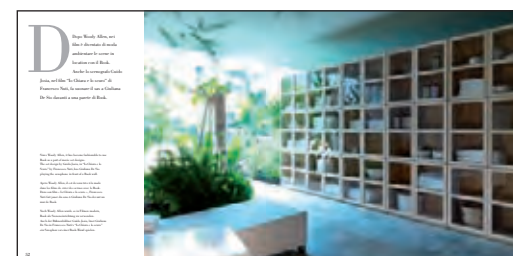

pag 52 -53 Book Natural Forever



pag 54 - 55 Book Walnut

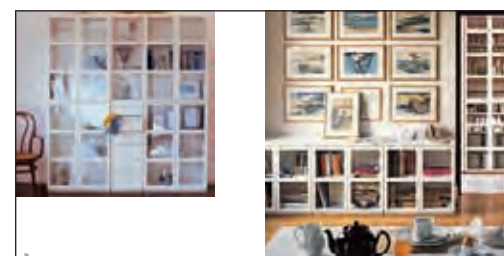

pag 56 - 57 Book Lipari White,  
Extra White

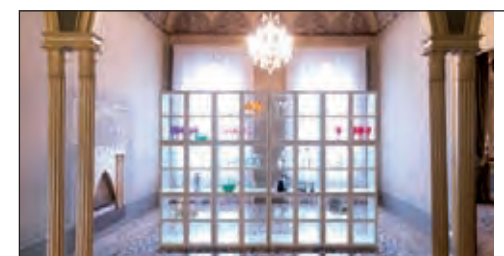

pag 60 - 61 Book Lipari White



pag 94 - 95 - Book "Mani"



Quando si disegna un'idea si desidera che questa possa vivere in eterno. Naturalmente nel design può essere difficile, perché con il passare degli anni, cambiano gli stili di vita e il modo di abitare.

Ma il Book ha degli elementi di seduttività, un giusto equilibrio tra estetica e funzionalità, una linearità, una duttilità, che non gli fanno sentire il passare del tempo. Forse il segreto è non avere nulla di troppo, essere un progetto levigato, in mezzo al quale si vive bene.

Forse è per questo che nelle case dei designer, in giro per il mondo, è facile trovarlo.

When designing an idea you wish this idea could live forever. Of course – if we talk about design – it may be difficult, because lifestyles and living habits change over the years. But Book is in a way seductive, there's the right balance between aesthetics and functionality, a linearity, a ductility, which make it impervious to time's flow. Possibly, the secret lies in not having "too much," in being an essential project, something people can live comfortably with. That might be the reason why one finds it so frequently in designers' homes, around the world.

Quand on dessine une idée, on souhaite qu'elle puisse vivre éternellement. Certes, dès lors qu'il s'agit de design, cela peut s'avérer difficile car les styles de vie et les tendances liées à l'habitation changent au fil des années. Mais le Book possède des éléments séduisants, un bon équilibre entre l'esthétique et la fonctionnalité, une linéarité et une ductilité qui le rendent imperméable au temps qui passe. Il est possible que le secret soit de ne rien avoir en trop, d'être un projet essentiel, au milieu duquel on puisse bien vivre. C'est peut-être pour cette raison qu'on le trouve souvent dans les maisons des designers, dans le monde entier.

Wenn man eine Idee zu Papier bringt, möchte man, dass sie ewig lebt. Natürlich kann das im Bereich des Designs schwierig sein, da sich Lebensstile und Wohnstile im Laufe der Jahre verändern. Aber Book ist auf eine bestimmte Art verführerisch, da ist das richtige Gleichgewicht zwischen Ästhetik und Funktionalität, eine Linearität, eine Duktilität, durch die es die Last der Jahre nicht zu spüren scheint. Möglicherweise liegt das Geheimnis darin, das es nicht zuviel hat, ein essentielles Projekt, etwas, womit man bequem leben kann. Das ist wohl der Grund dafür, dass das Möbel häufig in den Häusern von Designern rund um die Welt anzutreffen ist.





FRASSINO A PORO APERTO – OPEN PORE ASH

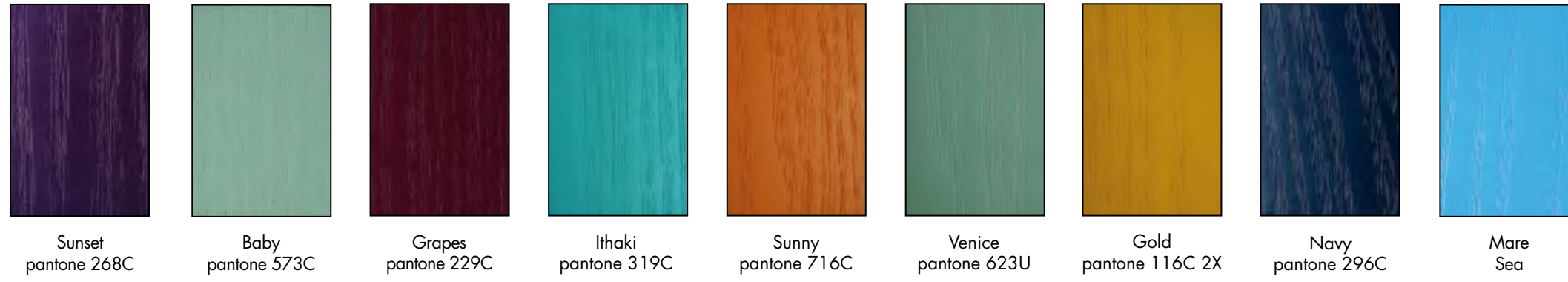

FINITURA GOFFRATA A PORO CHIUSO – COVERING EMBOSSED FINISHING

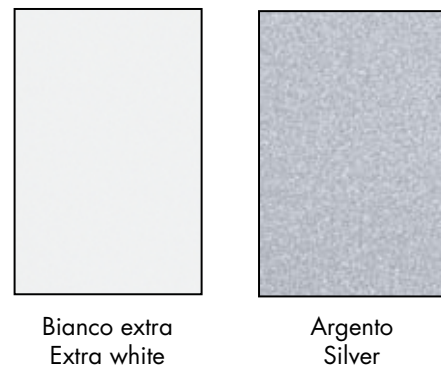

MISURE REALI REAL DIMENSIONS DIMENSIONS RÉELLES GENAUE MASSE

I numeri scritti tra parentesi sono le altezze comprensive di zoccolo da cm. 3,2  
 The numbers in brackets indicate the heights including a 3.2 cm-base socle  
 Les chiffres entre parenthèses indiquent les hauteurs socle de 3,2 cm inclus.  
 Die in Klammern gesetzten Maße beinhalten die evtl. Sockelhöhe von 3,2 cm.

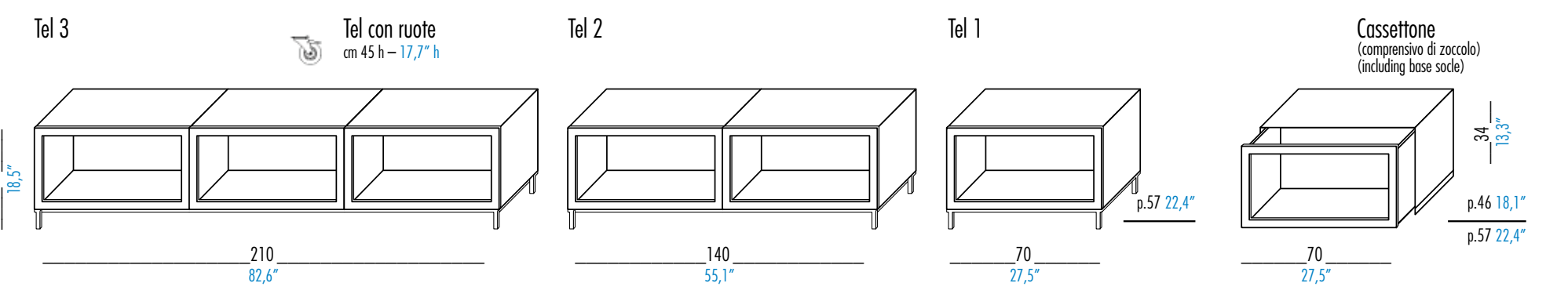
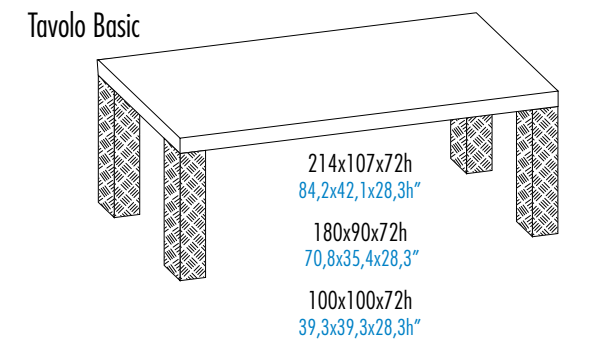
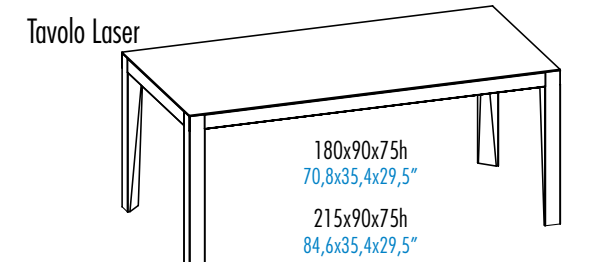
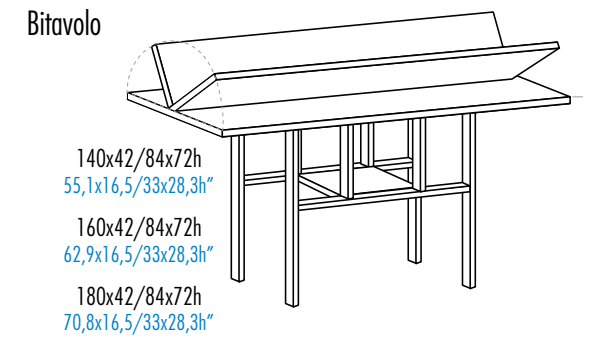
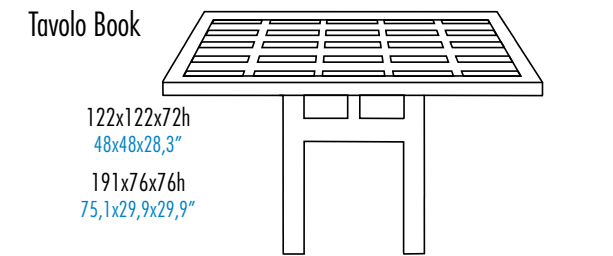
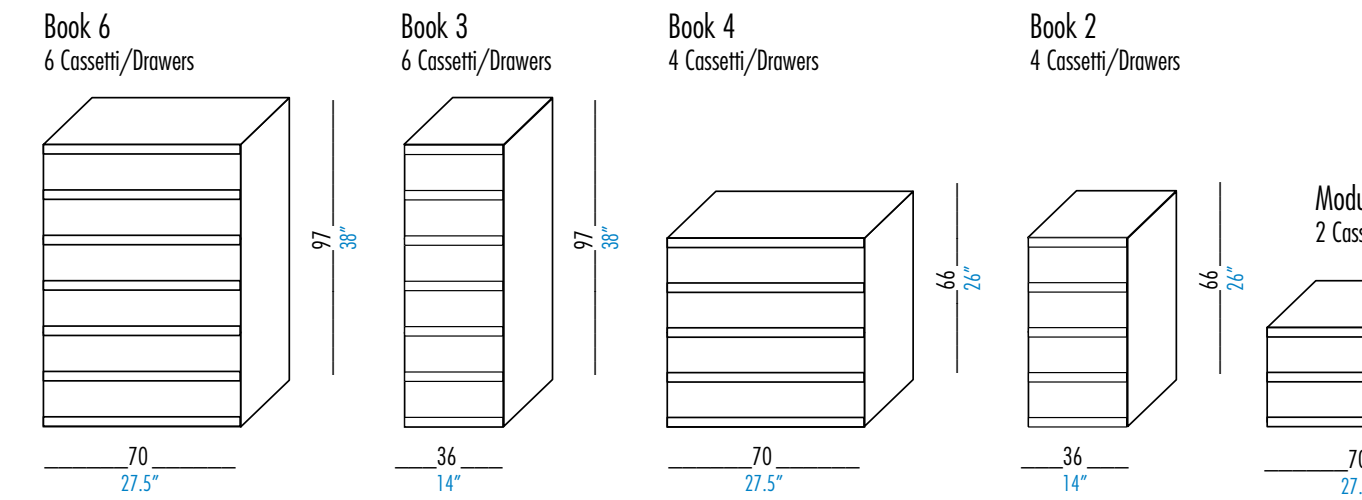
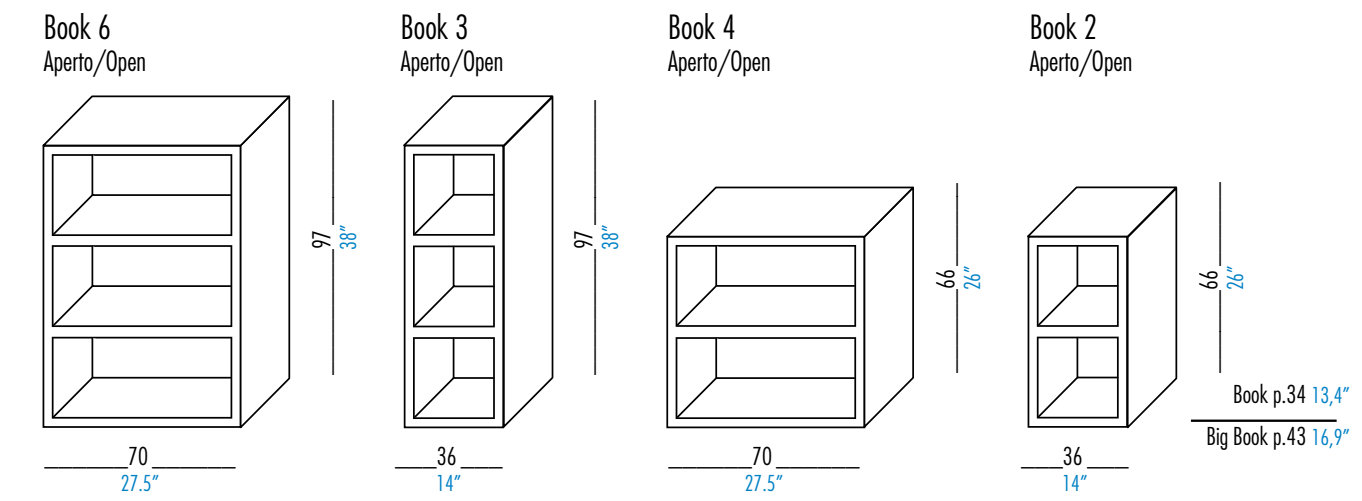
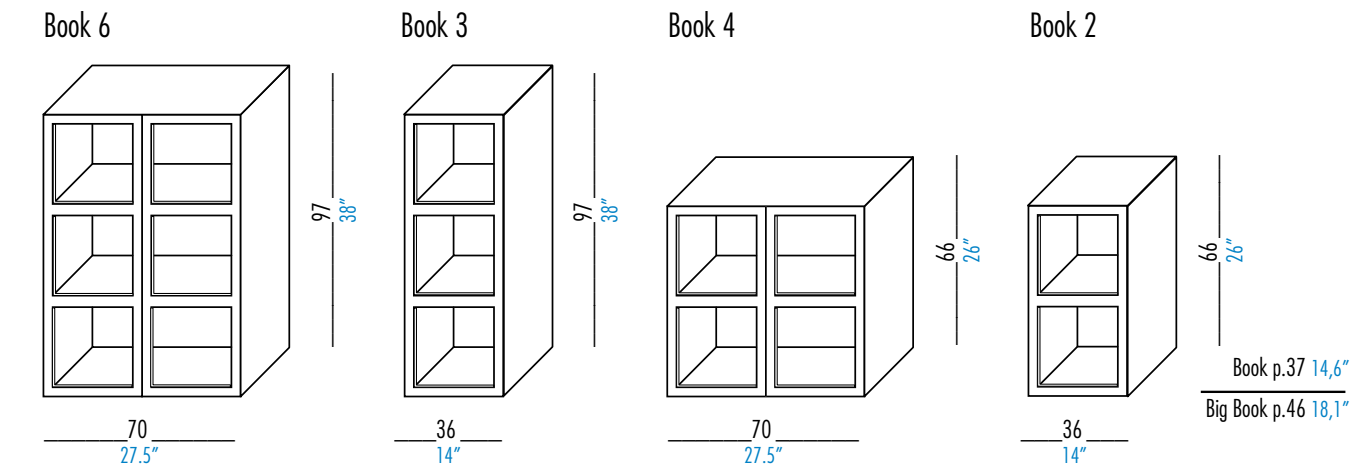
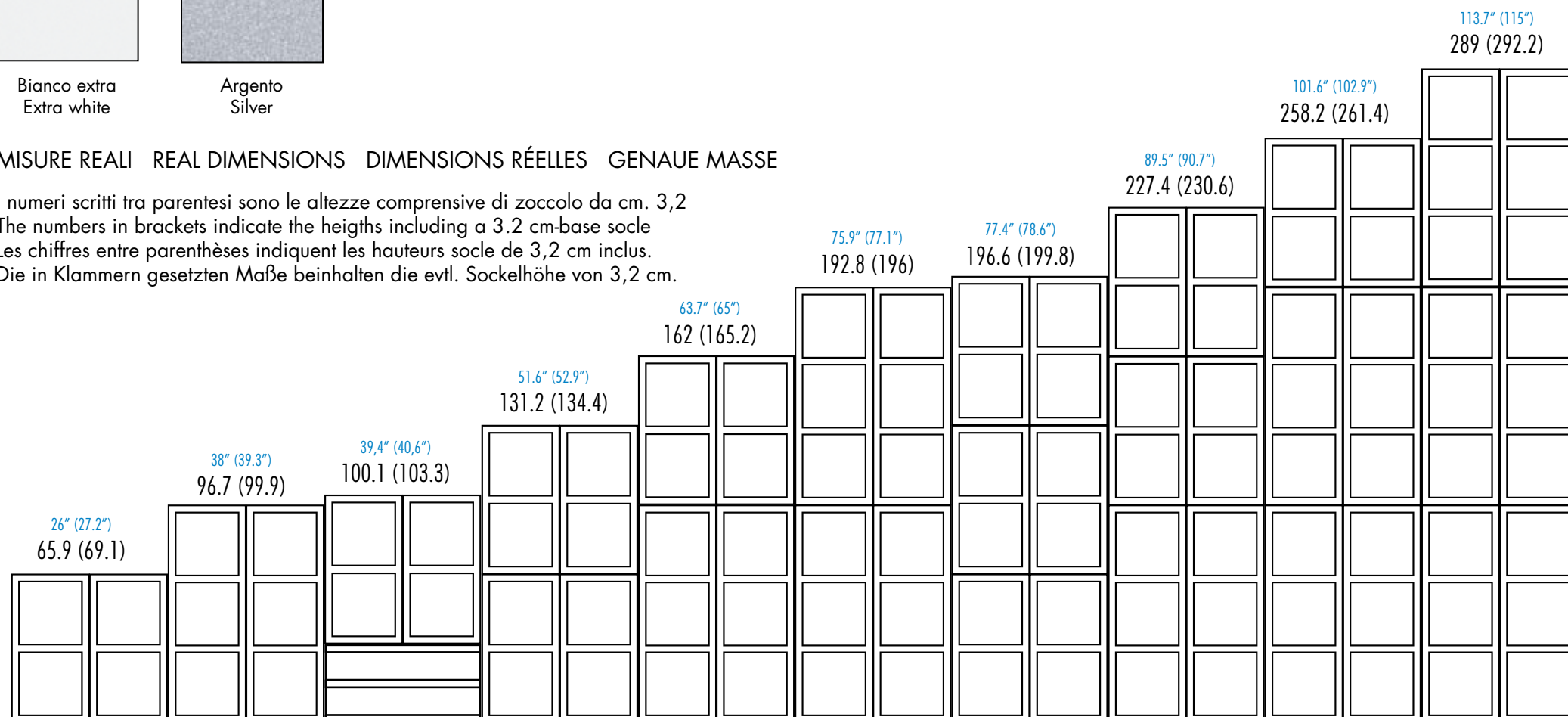



Book è il famoso sistema componibile di contenitori chiusi da vetri, aperti, a cassetti.

È costruito in Frassino a poro aperto nei colori: Naturale Sbiancato, Naturale Forever,

Bianco Lipari, Mare, Nero Stromboli, Mogano, Noce, Noce Moka, Noce Biondo, Smoky,

Antracite, o con finitura goffrata a poro chiuso nei colori: Argento, Bianco extra.

Dal 2012, Book ha nuovi colori a poro aperto: Sunset, Baby, Grapes, Ithaki, Sunny, Venice,

Gold, Navy.

Ante, frontali dei cassetti, top e fianchi di finitura sono anche disponibili in laccato

lucido bianco o nero.

La struttura in massello delle antine o

dei fianchi può essere supporto al vetro

trasparente, al plexiglass, al plexiglass

sabbiato, al vetro retrolaccato nero e bianco,

al vetro sabbiato o sabbiato a righe, allo

specchio argento o fumé, all’alluminio rigato,

alla carta paglia lago o laguna, al midollino

naturale o sbiancato, alla pelle moro, al legno

nei colori Book. I top sono disponibili nelle

varie finiture o in marmo Carrara anticato.

Book is the famous modular system comprising glass door cabinets, open cabinets or drawer cabinets.

It is made of ash and is available in the following colours: Whitened Natural, Forever Natural,,Lipari White, Sea Blue, Stromboli Black, Mahogany, Walnut, Mocha Walnut, Blonde Walnut, Smoky, Anthracite, or with embossed closed-pore finish In the colours Silver and Extra White.

As from 2012, Book comes with the following new colours: Sunset, Baby, Grapes, Ithaki, Sunny, Venice, Gold, Navy. The doors, drawer fronts, tops and side finishing panels are also available in the glossy lacquered white and black finish.

The solid wood structure of the doors and side panels may be combined with transparent glass, plexiglass, sandblasted plexiglass, white or black rear lacquered glass, sandblasted glass or striped sandblasted glass, with smoke-grey or silver mirror panels, with striped aluminium panels, straw paper panels with Lake or Lagoon finish, with natural or whitened wicker panels, with dark brown leather panels of wooden panels in the Book colours. The tops are available in the various finishes or in the antiqued Carrara marble version.

Book est le fameux système de rangement modulaire composé d’éléments à porte vitrée, ouverts ou à tiroirs. Il est réalisé en frêne dans les coloris suivants: naturel blanchi, naturel «forever», blanc Lipari, bleu mer, noir Stromboli, acajou, noyer, noyer moka, noyer blond, fumée, anthracite ou en finition gaufrée pores fermés dans les coloris argent et blanc extra.

Depuis 2012, Book se décline dans de nouveaux coloris : Sunset, Baby, Grapes, Ithaki, Sunny, Venice, Gold, Navy. Les portes, les façades de tiroir, les tops et les joues de finition existent aussi en laqué brillant blanc ou noir.

La structure en bois massif des portes ou des joues peut accueillir un verre transparent, du plexiglas, du plexiglas sablé, un verre laqué au dos en noir ou blanc, un verre satiné simple ou à rayures, un miroir argent ou fumé, de l’aluminium cannelé, du papier paille couleur lac ou lagune, de la moelle de rotin naturelle ou blanchie, du cuir marron foncé ou du bois dans les coloris Book. Les tops existent dans les différentes finitions ou en marbre de Carrare vieilli.

Book ist das bekannte modulare System mit unterschiedlichen Behältern: geschlossen mit Glastür, offen und Schubkästen. Das Möbel ist aus Esche in den Farben: Natur gebleicht, Natur Forever, Weiß Lipari, Schwarz Stromboli, Mahagoni, Nuss, Nuss Moka, Nuss hell, Smoky, Anthrazit oder in der Ausführung geschlossenporig gaufriert in den Farben: Silber, Weiß extra.

Seit 2012 hat Book neue Farben: Sunset, Baby, Grapes, Ithaki, Sunny, Venice, Gold, Navy. Die Schranktüren, Schubkastenfronten, Tops und Abschlusseiteile sind auch in der Glanzlackierung Weiß oder Schwarz erhältlich.

Die Furnierstruktur der Türen oder der Seitenteile kann mit transparentem Glas, rückseitig Weiß oder Schwarz lackiertem Glas, Spiegelglas silber- oder rauchfarben, Aluminium mit Streifen- oder Lochdekor, Bastpapier Lago oder Laguna, Pedding natur oder gebleicht, Leder Dunkelbraun, Holz in den Farben Book ausgestattet werden. Die Tops sind in den verschiedenen Ausführungen oder aus Marmor Carrara antik erhältlich.

redazione e progetto grafico

Titti Fabiani e Lorenzo Betti van der Noot

fotografia di

Thomas Libiszewski

Alessandro Paderni / Eye

Orio Raffo

Allegra Betti van der Noot

## Ideal Form Team

è un’azienda delle Marche

dove il tempo si è fermato.

Il legno è il migliore,

la lavorazione meticolosa

e sapiente.

Le persone impegnate

a offrire solo il meglio.



Titti Fabiani



I D E A L  
F O R M  
T E A M



VIA PIEMONTE 14  
60030 MONSANO  
(AN) ITALY  
TEL. +39 0731 605531  
FAX +39 0731 60010  
[www.idealformteam.com](http://www.idealformteam.com)  
[ift@idealformteam.com](mailto:ift@idealformteam.com)